

Y87JOS04XX *Linea Standard*

Porta doccetta doccia con impugnatura ergonomica, manovrabile con una sola mano

Dati fisici

Dimensioni (mm.)	95x116x163
Peso (kg.)	0,160





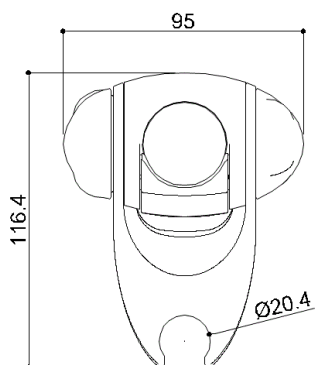
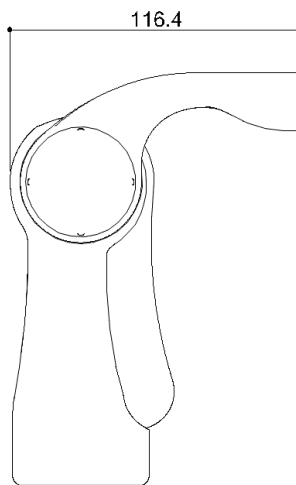
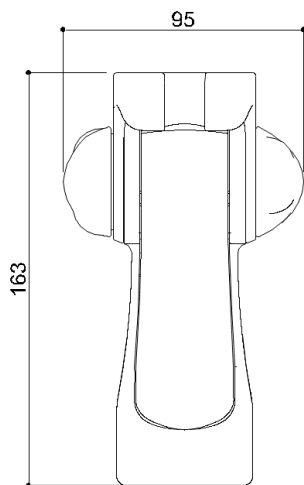











Metodi di imballo

Imballo	Imballo in polietilene
Dimensioni dell'imballo (mm.)	205x120x85
Peso con imballo (kg.)	0,26



Y87JOS04XX *Linea Standard*

Colori disponibili

 B1 Blu	 B2 Celeste Pastello	 C1 Cromo
 D1 Nero	 D2 Grigio Pietra	 D4 Grigio Scuro
 G1 Verde Erba	 G2 Verde pastello	 I1 Avorio
 I2 Biscotto	 P4 Prugna	 R1 Rosso vivo
 R7 Rosso Rubino	 W1 Bianco latte	 Y1 Giallo Sole
 Y3 Giallo Chiaro		

Materiali e finiture

ABS	Lucida
-----	--------

Suggerimenti per la sicurezza

Prima di installare e utilizzare il dispositivo, leggere attentamente le istruzioni per l'uso e in modo particolare le avvertenze sulla sicurezza, attenendosi ad esse.

In caso di dubbi, prima di utilizzare il dispositivo contattare l'azienda.

Informazioni sull'uso

Il dispositivo non risente della temperatura dell'ambiente e comunque NON deve essere installato in ambienti soggetti a temperature minore di 4 °C o maggiore di 40 °C .

Non installare in saune. Non rispettare le temperature indicate potrebbe danneggiare il rivestimento in plastica del dispositivo.

Garanzia

La garanzia ha una durata di 2 anni; se in questo periodo si manifestano difetti di materiale o di lavorazione Ponte Giulio S.p.A. provvederà a riparare o sostituire gratuitamente il prodotto.