

## Y87JOS02XX *Linea Standard*

Porta doccia

### Dati fisici

Dimensioni (mm.)	117x78,5x44
Peso (kg.)	0,09





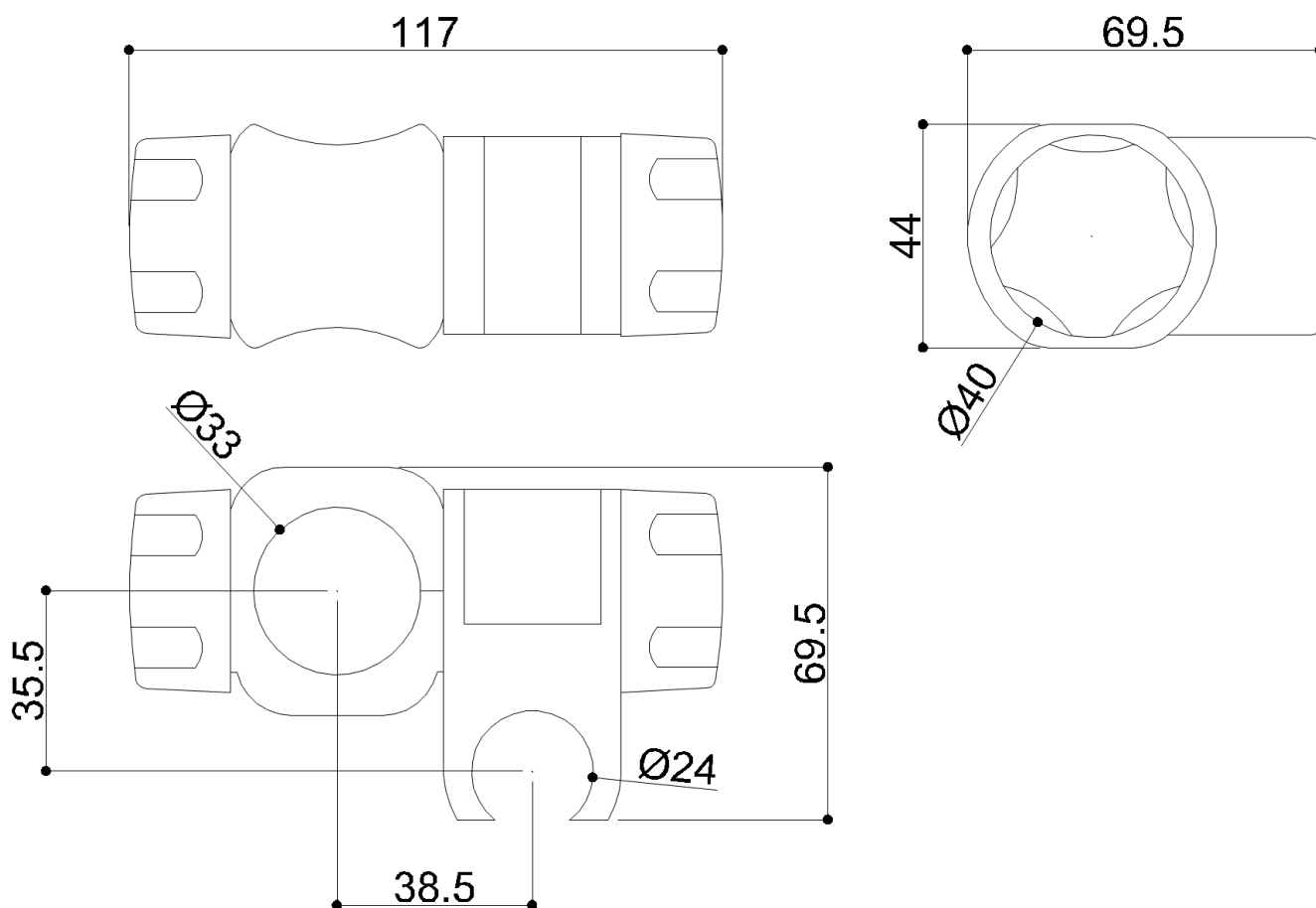











### Metodi di imballo

Imballo	Imballo in polietilene
Dimensioni dell'imballo (mm.)	125x80x55
Peso con imballo (kg.)	0,1



## Y87JOS02XX *Linea Standard*

### Colori disponibili

<b>B1</b>  Blu	<b>B2</b>  Celeste Pastello	<b>C1</b>  Cromo
<b>D1</b>  Nero	<b>D2</b>  Grigio Pietra	<b>D4</b>  Grigio Scuro
<b>G1</b>  Verde Erba	<b>G2</b>  Verde pastello	<b>I1</b>  Avorio
<b>I2</b>  Biscotto	<b>P4</b>  Prugna	<b>R1</b>  Rosso vivo
<b>R7</b>  Rosso Rubino	<b>W1</b>  Bianco latte	<b>Y1</b>  Giallo Sole
<b>Y3</b>  Giallo Chiaro		

### Materiali e finiture

Poliammide	Lucida
------------	--------

### Suggerimenti per la sicurezza

Prima di installare e utilizzare il dispositivo, leggere attentamente le istruzioni per l'uso e in modo particolare le avvertenze sulla sicurezza, attenendosi ad esse.

In caso di dubbi, prima di utilizzare il dispositivo contattare l'azienda.

### Informazioni sull'uso

Il dispositivo non risente della temperatura dell'ambiente e comunque NON deve essere installato in ambienti soggetti a temperature minore di 4 °C o maggiore di 40 °C .

Non installare in saune. Non rispettare le temperature indicate potrebbe danneggiare il rivestimento in plastica del dispositivo.

### Garanzia

La garanzia ha una durata di 2 anni; se in questo periodo si manifestano difetti di materiale o di lavorazione Ponte Giulio S.p.A. provvederà a riparare o sostituire gratuitamente il prodotto.