

F17ATN01XX *Range* Nylon

Mirror holders - Four pieces kit

Physical data

Dimensions (mm.)	39x12x63
Weight (kg.)	0,070





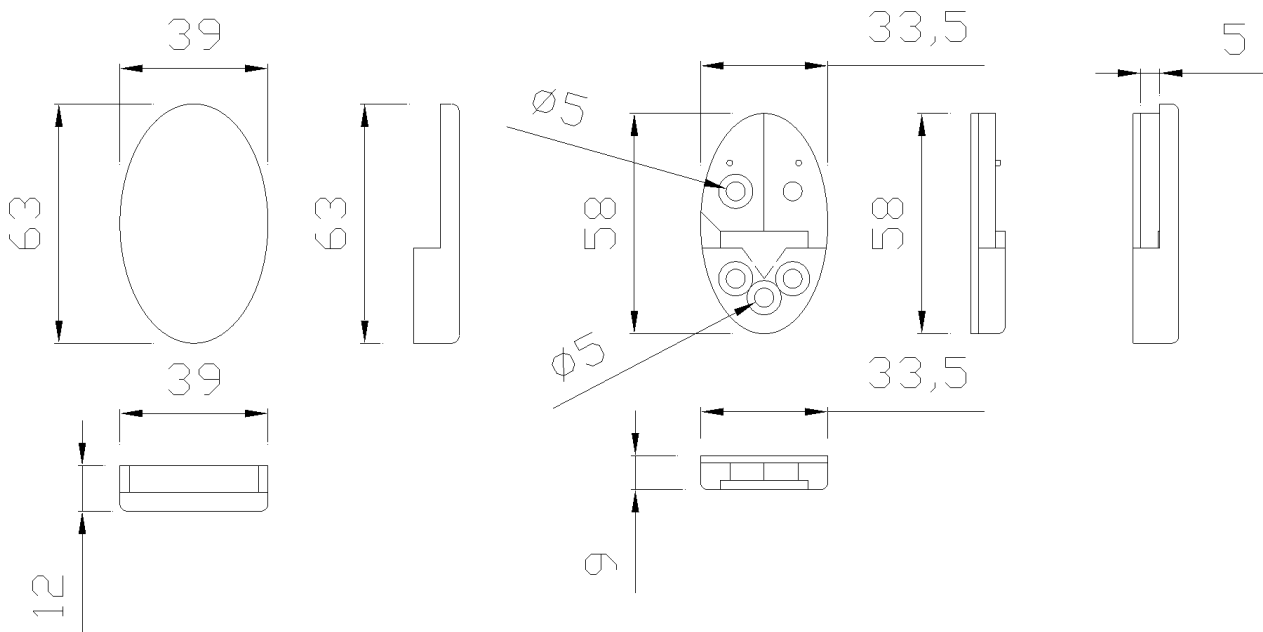









Delivery methods

Package	Polyethylene package
Package dimensions (mm.)	45x170x160
Weight with Packaging (kg.)	0,075



F17ATN01XX Range Nylon

Available colors

 B1 Blue	 B2 Light blue	 D1 Black
 D2 Greystone	 D4 Dark Grey	 G1 Green
 G2 Light Green	 I1 Ivory	 I2 Biscuit
 P4 Prune	 R1 Vivid Red	 W1 White
 Y1 Yellow Sun	 Y3 Light yellow	

Safety tips

Before installing and using the device, read the instructions for use and especially the safety warnings carefully and follow them. If in doubt, contact the company before using the device.

Information on use

The device is not affected by the room's temperature, though it must NOT be installed in environments subject to temperatures below 4°C or above 40°C.

Do not install in saunas. Not comply with the indicated temperatures may damage the plastic coating of the device.

Materials and finishes

Polyamide Polished

Warranty

If this product fails due to a defect in material or workmanship during the time of periods listed below for each product, Ponte Giulio will replace or repair it free of charge. .

Warranty 2 YEARS